

KODAK PIXPRO FZ53

DIGITAL CAMERA

User Manual



BEFORE YOU START

Declaration of Conformity

Responsible Party: JK Imaging Ltd.

Address: JK Imaging Ltd., 17239 So. Main Street, Gardena, CA 90248 USA

Company website: kodakpixpro.com

For Customers in the USA

Tested to Comply with FCC Standards FOR HOME OR OFFICE USE

This device complies with part 15 of the FCC Rules. Operation is subject to the following two conditions: (1) This device may not cause harmful interference and (2) this device must accept any interference received, including interference that may cause undesired camera operation.

For Customers in Europe

 "CE" mark indicates that this product complies with the European requirements for safety, health, environment and customer protection. "CE" marked cameras are intended for sales in Europe.

 This symbol [crossed-out wheel bin WEEE Annex IV] indicates separate collection of electrical waste and electronic equipment in the European countries. Please do not throw the equipment into domestic refuse. Please use the return and collection systems available in your country for proper, safe disposal of this product.

 Batteries: Please dispose of used batteries at designated collection centers.

 Packaging: Please follow local regulations for the recycling of packaging.

About this Manual

Thank you for purchasing this KODAK PIXPRO Digital Camera. Please read this manual carefully and keep it in a safe place for future reference.

- JK Imaging Ltd. reserves all rights of this document. No part of this published manual may be reproduced, transmitted, transcribed, stored in a retrieval system or translated into any language or computer language, in any form, by any means, without the prior written permission of JK Imaging Ltd..
- All trademarks mentioned in this manual are used for identification purposes only and are properties of their respective owners.
- This manual provides you with instructions on how to use your new KODAK PIXPRO Digital Camera. Every effort has been made to ensure that the contents of this manual are accurate; however JK Imaging Ltd. reserves the right to make changes without notice.
- Throughout this manual, the following symbols are used to help you locate information quickly and easily:



Indicates useful information.

- The following symbols may be used throughout this manual to facilitate your understanding of how to operate the camera:

[Item properties]: The optional properties in the camera interface are indicated by the [] symbol.

SAFETY NOTES

Safety Notes for this Camera

- Do not drop the camera or allow it to hit solid objects.
- Do not attempt to disassemble or repair the camera.
- Do not use or store the camera in dusty places or on a beach to help prevent dust or sand from entering the camera, causing possible damage.
- Do not use or store the camera in a hot environment or in direct sunlight.
- Do not use or store the camera near powerful magnetic fields, for example near a magnet or transformer.
- Avoid touching the lens of the camera.
- Do not expose the camera to direct sunlight for a long period of time.
- To prevent the camera from being damaged by moisture, do not use or store the camera in very humid environments, such as in rain or near bodies of water.
- If water accidentally comes in contact with the camera, turn the camera off immediately, remove the battery and the memory card and dry it completely within 24 hours.
- When you take the camera from a cold environment to a warmer environment, condensation may occur. Please wait for a reasonable period of time before you turn the camera on.
- Before you remove the battery and memory card, the camera should be turned off.
- When you clean the body of the camera, do not use abrasive, alcohol-based or organic cleansers or solvents.
- Use a professional lens cleaning cloth and appropriate cleaner to wipe and clean the lens.
- Download your photos and remove the memory card when you are going to store the camera for long periods of time.
- If this camera is not in use for a long period of time, please keep it in a dry and clean storage location.
- Our company will not pay compensation for any failure of playback including: pictures or videos damaged or unrecoverable by improper operation.

Safety Notes for Battery

- Please use a battery that is the same type as the one included.
- Please use the attached charger to charge the battery.
- If battery fluid leaks inside the camera, contact our customer service department immediately. If battery fluid leaks onto your skin, rinse your skin with clean water and seek immediate medical attention.
- Disposal of used batteries should be carried out in accordance with your local (national or regional) regulations.
- To prevent the battery from being damaged, do not drop the battery or allow it to hit solid objects or to be scratched by foreign objects.
- Do not let the battery come in contact with metal objects (including coins) to avoid short circuiting, discharging, excessive heat or possible leakage.
- Do not attempt to disassemble the battery.
- Do not expose the battery to water. Always keep the battery contacts dry.
- Do not heat the battery or throw it into a fire to avoid a possible explosion.
- Do not store the battery in a hot environment or in direct sunlight.

- If the battery overheats during charging or use, stop charging or use immediately. Turn off the product, remove the battery carefully and wait until it cools down.
- When the camera is stored for a long period of time, remove the battery and keep it in a safe, dry place that is not accessible to infants and children.
- In colder environments, the performance of the battery could be noticeably reduced.
- When you install the battery, align the battery markings according to the positive and negative markings inside the camera battery compartment. Never force the battery into the battery compartment.

Safety Notes for Memory Cards

- We highly suggest buying only well-known, name brand memory cards to ensure peak performance and reliability.
- Format the memory card using the camera before you use it or insert a new one.
- Do not drop the memory card or allow it to hit solid objects to avoid damaging it.
- Do not attempt to disassemble or repair the memory card.

- Do not expose the memory card to water. Always keep it dry.
- Do not remove the memory card when the camera is turned on. Otherwise, the memory card and photo/video files could be permanently damaged.
- Do not directly edit the data on the memory card. Copy the data to your computer before you edit files.
- When the camera is stored for long periods of time, be sure to download your photos and remove the memory card. Store the memory card in a dry environment.
- Do not modify the name of the files or folders of the memory card using your computer. Modifying the file names may cause the files to not be recognized on the camera or a possible permanent error may occur.
- A photo taken with the camera will be stored in the folder that is automatically generated on the memory card. Do not store photos that are not taken using this camera in these folders as the pictures cannot be recognized during playback.
- When you insert the memory card, make sure the notch of the card matches the markings on the top of the camera card slot.

Other Safety Notes

- Do not disconnect the power or turn the camera off during the update process. Doing so may cause incorrect data to be written and the camera may not power on later.
- Do not hang the neck strap of the camera around the neck of a child.
- When using your camera on an airplane, observe the relevant rules specified by the airline and FAA regulations.
- Due to the limitations of manufacturing technology, the LCD may have a few dead or bright pixels. These pixels do not affect the quality or performance of the camera, photos or video.
- Do not expose the camera's LCD to water. In a humid environment, only wipe it with a soft, dry, cleaning cloth.
- If the LCD is damaged and the liquid crystal comes into contact with your skin, wipe your skin with a dry cloth immediately and rinse it with clean water. If liquid crystal comes into contact with your eyes, wash them with clean water at least for 15 minutes and seek immediate medical attention. If you accidentally swallow liquid crystal, rinse your mouth immediately and seek medical attention.

WARNING

- Altering, tampering or modifying the any parts of FZ53 camera are unauthorized and will void the manufacturer's warranty and "could" void Federal and/or State Compliance.
- This equipment has been tested and found to comply with the limits for a Class B digital device, pursuant to part 15 of the FCC Rules. These limits are designed to provide reasonable protection against harmful interference in a residential installation.

This equipment generates, uses, and can radiate radio frequency energy and, if not installed and used in accordance with the instructions, may cause harmful interference to radio communications. However, there is no guarantee that interference will not occur in a particular installation.

If this equipment does cause harmful interference to radio or television reception, which can be determined by turning the equipment off and on, the user is encouraged to try to correct the interference by one or more of the following measures:

- Reorient or relocate the receiving antenna
- Increase the separation between the equipment and receiver
- Connect the equipment into an outlet on a circuit different from that to which the receiver is connected
- Consult the dealer or an experienced radio/TV technician for help

CONTENTS

BEFORE YOU START	1	MODE OVERVIEW	21
SAFETY NOTES	3	Display Setting	21
CONTENTS.....	7	LCD Screen Display	22
GETTING STARTED.....	11	Overview of the Screen Icons in Photo Shooting Mode	22
Accessories Included.....	11	Overview of the Screen Icons in Movie Mode.....	24
Part Names	12	Overview of the Screen Icons in Playback Mode.....	25
Installing Battery and Memory Card.....	15	Using the Mode Button	26
Charging the Battery.....	17	Manual Mode	27
Turning Camera On and Off.....	18	Auto Mode	27
How to Take Pictures.....	18	Anti-shake	28
Set your Language, Date/Time	19	Portrait	28
Set your Language, Date/Time after the First Power-On.....	19	Panorama Mode	29
Resetting your Language.....	19	Scene Mode (SCN).....	30
Resetting Date/Time	20	Auto Scene Mode (ASCN).....	33

Movie Mode	34	Slideshow	45
BASIC OPERATION.....	35	Photos and Video Deletion	46
Using the Zoom Function.....	35	USING THE MENUS	47
Macro Mode.....	36	Photo Setup Menu.....	47
Self-Timer Setting.....	37	Expo Metering (Exposure Metering)	47
Flash Mode	38	Image Size.....	48
EV Setting	39	Continuous AF.....	48
Exposure Compensation	39	Continuous Shot	49
ISO	40	Focus Setting	50
Shutter Adjustment.....	40	White Balance Setting	50
Using Quick Recording	41	Color Effect	51
PLAYBACK	42	Photo Shooting Setting Menu	53
Viewing Photos and Videos	42	Quality	53
Thumbnail View	43	AF Assist Beam.....	54
Using Zoom Playback (for still pictures only) .	44	Digital Zoom	54
		Date Imprint	55

Quick Review.....	55	DPOF (Digital Print Order Format).....	64
Movie Menu	56	Trim.....	65
Expo Metering (Exposure Metering)	56	Setup Menu	66
Video Quality.....	57	Sound Settings.....	67
Color Effect	57	Power Saver.....	67
Movie Setting Menu	58	Language.....	67
Digital Zoom.....	58	World Time	68
Playback Menu	59	Date & Time.....	68
HDR.....	59	File / Software	68
Red-Eye Reduction.....	60	Format	68
Rotate	60	Copy to Card.....	69
Resize	61	File Numbering.....	69
Color	61	Reset.....	70
Playback Setting Menu	62	Firmware (FW) Version	70
Protect.....	62	CONNECTIONS.....	71
Delete	63	Connecting to a Computer.....	71

Setting the USB Mode	71	Prompts and Warning Messages	84
Transferring Files to Your Computer	71	Troubleshooting	88
Video System	72	Memory Card Compatibility	90
Set Eye-Fi SD Card Connection Mode.....	73		
Connecting to PICTBRIDGE™ Compatible Printers.....	74		
Setting the USB Mode	74		
Connecting to your Printer	75		
Using the PICTBRIDGE™ Menu.....	76		
Print (with Date)	76		
Print (without Date).....	77		
Print Index	78		
Print DPOF Images	79		
Exit.....	79		
APPENDICES	80		
Specifications.....	80		

GETTING STARTED

Accessories Included

Your camera box should contain the camera model you purchased along with the following accessories. If anything is missing or appears to be damaged, please contact your retailer first or our customer service center. (The battery chargers may be a little different in shape due to the difference of countries or regions this type of cameras are sold to, and are subject to matching the physical product).

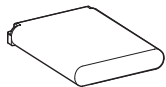

Rechargeable Li-ion Battery

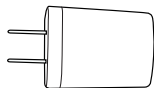

AC Adapter
(Optional)

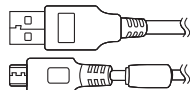

Micro USB Cable



Wrist Strap



Quick Start Guide



Warranty Card



Service Card

Part Names

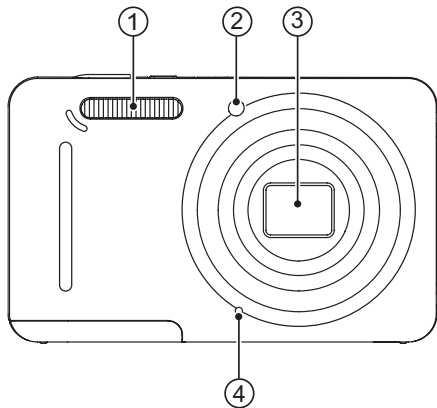

1. Flash Lamp
2. AF Assist Beam/
Self-Timer Lamp
3. Lens
4. Microphone

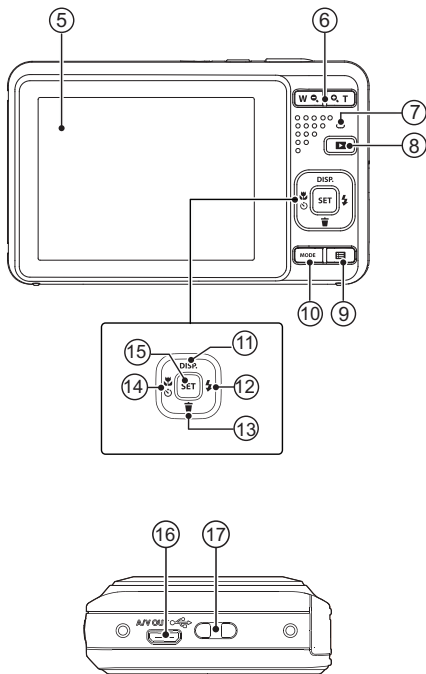

- 5. LCD
- 6. Zoom Button
- 7. Indicator Lamp
- 8. Playback Button
- 9. Menu Button
- 10. Mode Button
- 11. Display Button/Arrow Button (Up)
- 12. Flash Button/Arrow Button (Right)
- 13. Delete Button/Arrow Button (Down)
- 14. Macro Button/Self-Timer Button/
Arrow Button (Left)
- 15. SET Button

- 16. Micro USB/AV Port
- 17. Strap Eyelet

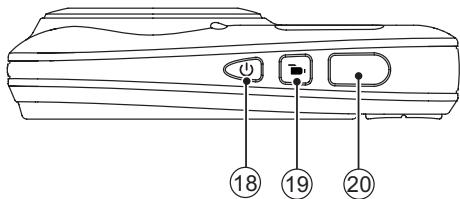

- 18. Power Button
- 19. Quick Video Recording Button
- 20. Shutter Button

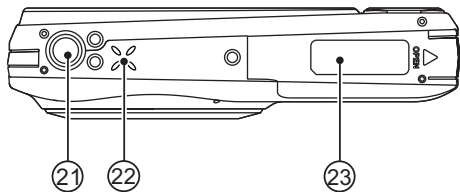

- 21. Tripod Socket
- 22. Speaker
- 23. Battery Cover

Installing Battery and Memory Card

1. Open the battery cover door.

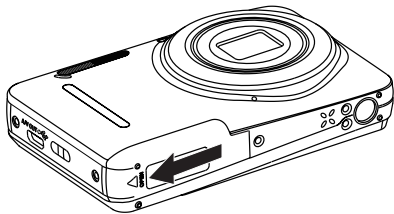

2. Insert the battery into the battery slot in the correct direction as shown in the following diagram.

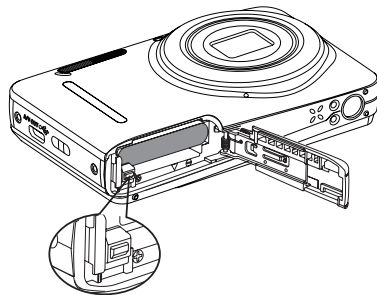
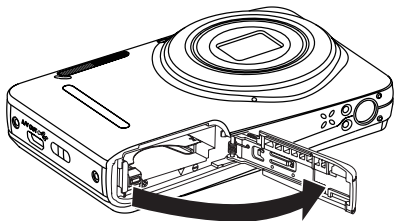
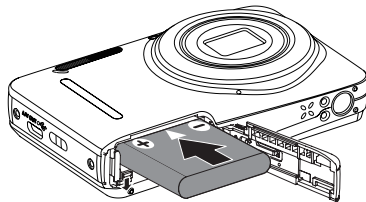

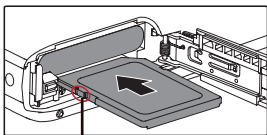

3. Insert the memory card into the memory card slot as shown in the diagram below:

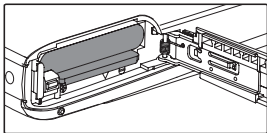

Write Protection Toggle Switch



-  A memory card (SD/SDHC) is optional and not included in all camera packaging. It needs to be purchased separately. Please use an original memory card which is Class 4 or higher and has a capacity of 4GB to 32GB.
-  To remove your memory card, open the battery cover door, gently press the memory card to eject it and remove it carefully.

4. Close the battery cover door.

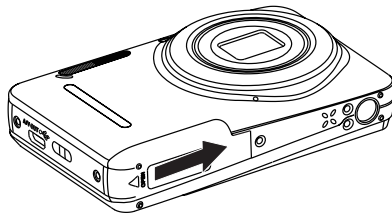
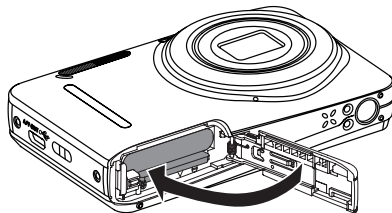



Charging the Battery

Before you charge your battery, you should turn the camera off and insert the battery.

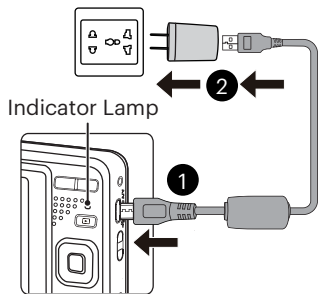
1. Connect the camera to the power charger using the supplied USB cable.
2. Insert the plug of the power charger into the wall outlet to charge the battery.





 The charger is for indoor use only.

 After the battery is stored for long periods of time, use the supplied power charger to fully charge the battery prior to use.

 **Charging Indicator:**
Steady orange : Charging
The indicator lamp will go out once charging is finished and the camera will power off automatically. To maximize battery life, charge the battery for at least 4 hours the first time.

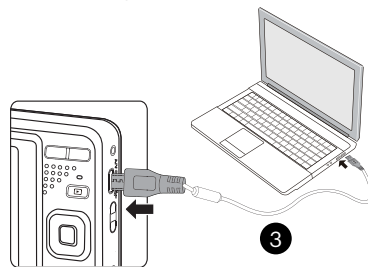
 When the camera is turned off, you can also connect the camera to your PC using a USB cable to charge the battery.



 Please charge the battery indoors between 0°C and 40°C (32°F and 104°F).

Turning Camera On and Off

Press the Power button to turn the camera on. To turn the camera off, press the Power button again.

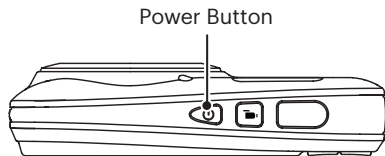







When the power is off, press and hold the play  button to power on and enter Playback mode.

How to Take Pictures

1. Hold the camera with both hands, being careful to not block the flash and lens with fingers.
2. Point the lens toward the object you want to take a picture of, then frame it with the LCD.
3. Use the Zoom button to select Tele or Wide positions to zoom in or out on your subject.
4. Press the shutter button halfway to focus on the subject. When the focus frame turns green, press the shutter button down completely to take the picture.



Set your Language, Date/Time

Set your Language, Date/Time after the First Power-On

1. When you turn the camera on for the first time, the language selection screen appears.
 2. Press the arrow buttons to select your desired language.
 3. After you press the  button to confirm your language selection, the Date/Time settings screen will appear.
 4. Press the left/right arrow buttons to select the Date/Time to be adjusted: Time is displayed in YYYY.MM.DD/HH:MM.
 5. Press the up/down arrow buttons to adjust the value for the desired Date/Time.
 6. Press the  button to confirm the time settings and the snapshot screen will appear.
2. Press the up/down arrow buttons to select , and press the  button or right arrow button to enter the menu.
 3. Press the up/down arrow buttons to select [Language] and press the  button or right arrow button to enter the menu.
 4. Press the arrow buttons to select your desired language and press the  button to confirm.
 5. Press the  button and the snapshot screen will appear.

Resetting your Language

After you set your language for the first time, follow the instructions below to reset your desired language.



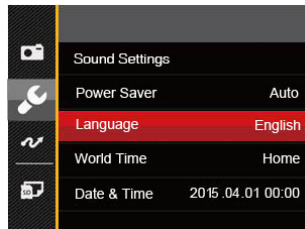



1. Press the  button and press the up/down arrow buttons to select . Press the  button to enter the menu.







Resetting Date/Time

After you set your Date/Time for the first time, follow the instructions below to reset date and time.

1. Press the  button and press the up/down arrow buttons to select . Press the  button to enter the menu.
2. Press the up/down arrow buttons to select  and press the  button or right arrow button to enter the menu.
3. Press the up/down arrow buttons to select [Date & Time] and press the  button or right arrow button to enter the menu.
4. Press the left/right arrow buttons to select the Date/Time to be adjusted: Time is displayed in YYYY.MM.DD/HH:MM.

5. Press the up/down arrow buttons to press the value for your selected entry. After you finish your settings, press the  button to confirm.
6. Press the  button and the following snapshot screen will appear.

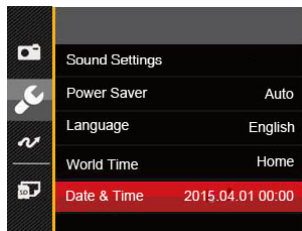

MODE OVERVIEW

Display Setting

Press the **DISP.** button to display the settings:
Classic, Full, Off.

Classic: Displays the camera parameters on screen



Off: Does not display any additional icons on screen

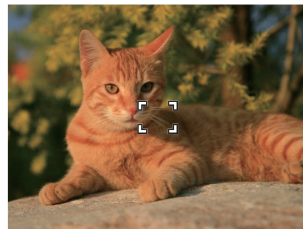

Full: Camera parameters with Grid and Histogram

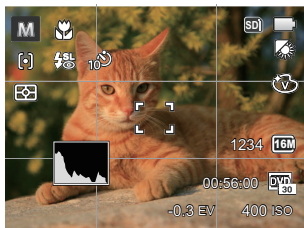

LCD Screen Display

Overview of the Screen Icons in Photo Shooting Mode

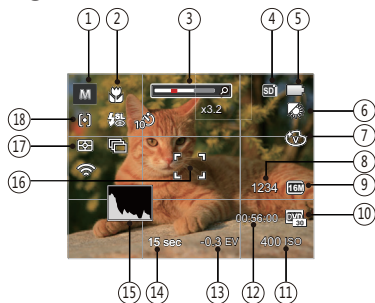

1 Shooting Mode Icons



2 Macro Mode

3 Zoom Display

4 Memory Card/Built-In Memory

5 Battery Status

6 White Balance (Adjustable in Mode)

7 Color Effect (Adjustable in Mode)

8 Number of Remaining Shots

9 Image Size

10 Video Quality

11 ISO Value (Adjustable in Mode)

12 Remaining Recording Time

13 Exposure Compensation (EV Value) (Adjustable in Mode)

14 Shutter Speed (Adjustable in Mode)

15 Histogram

16 Focus Frame

17 Expo Metering

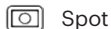



18 AF Mode

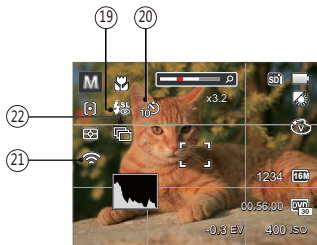





19 Flash Mode

-  Force Off
-  Flash Auto
-  Fill Flash
-  Slow Sync.
-  Slow Sync. + Red-Eye
-  Red-Eye Reduction

20 Self-Timer

-  Self-Timer Off
-  Self-Timer 2 sec

 Self-Timer 10 sec

 Self-Timer Smile

21 Eye-Fi ON (with signal)

22 Continuous Shot

 Single

 Continuous Shot

 3 Shots

 Time-Lapse (30sec/1min/5min/10min)

Overview of the Screen Icons in Movie Mode

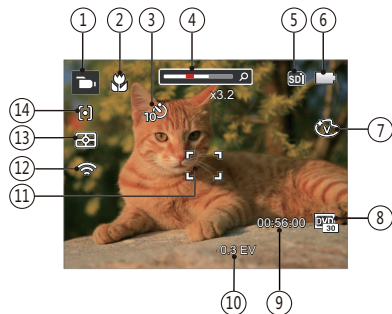

1 Movie Mode Icons

2 Macro Mode

3 Self-Timer



Self-Timer Off



Self-Timer 10 sec

4 Zoom Display

5 Memory Card/Built-In Memory

6 Battery Status

7 Color Effect

8 Video Quality

9 Remaining Recording Time

10 Exposure Compensation (EV value)

11 Focus Frame

12 Eye-Fi On (with signal)

13 Expo Metering



AiAE



Spot



Center

14 AF Mode



For optimal video shooting, it is recommended that an SDHC memory card be used.



Optical Zoom and Digital Zoom can be adjusted (30X in total). Digital Zoom can be adjusted to 6X.



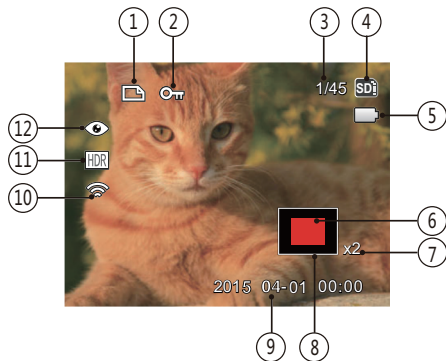



Overview of the Screen Icons in Playback Mode



- 1 DPOF File
- 2 File Protection
- 3 Memory space (indicating the current number of photos and total number of photos)
- 4 Memory Card/Built-in Memory
- 5 Battery Status
- 6 Zoom Magnification Area
- 7 Image Zoom Ratios
- 8 Image Zone
- 9 Shooting Date
- 10 Eye-Fi On (with signal)
- 11 HDR
- 12 Red-Eye Reduction

Using the Mode Button

This camera provides a convenient Mode button that allows you to switch easily among different modes. After pressing the Mode button to enter the Mode Selection Menu, press the left/right button to choose the selected mode. Press the  button to confirm your selection. All the available modes are listed below:

Mode Name	Icon	Description
Manual Mode		Many of the camera settings can be configured manually in this mode.
Auto Mode		In this mode, the optimal conditions for taking pictures will be set based on the subject and environment. It is the most commonly used mode for taking pictures.
Anti-shake		Digital image stabilization to take clear pictures in the handheld state.
Portrait		The best setting for portrait shooting, enables AE/AF for faces.
Panorama Mode		In this mode, up to 4 frames can be stitched together to create a single panoramic photo.
Scene Mode		Choose from 21 different pre-set scene types and effects for your photos.
Movie Mode		Record videos.

Manual Mode **M**

When selecting manual (**M**) mode, you can set the EV / shutter speed manually and ISO value.

1. Press the **MODE** button to select manual exposure mode **M**, press **SET** button to confirm.

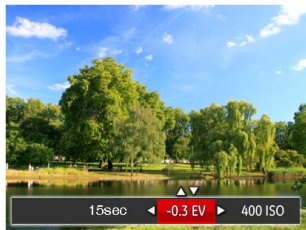

2. Press the left/right arrow buttons to select an adjustment setting.
3. Press the up/down buttons to adjust the parameters.
4. Press the **SET** button to confirm the settings and enter the shooting screen.

Auto Mode

Auto mode is the most common and easiest mode to take photos. While operating in this mode, the camera automatically optimizes numerous camera settings to optimally adjust settings for your photos and videos for the best possible results.



Follow these steps:

1. Press the **MODE** button to select auto mode ().
2. Compose your picture in the LCD and press the shutter button halfway down to focus on the subject.
3. The LCD will show a green focus frame when the subject is in focus.
4. Fully press down the shutter button to take your photo.

Anti-shake

This mode can help reduce photo blur caused by hand shake, low light and/or slow shutter speed.



-  Use Anti-shake mode in dark environments or when using a slower shutter speed.
-  Shooting in a windy or unstable environment (such as a moving vehicle) may cause blurred images.

Portrait

In Portrait Mode, the camera is set to automatically adjust exposure for realistic capture of skin tones.

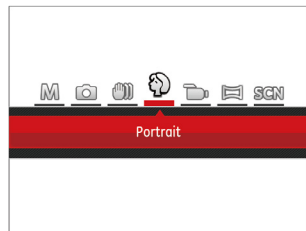

Press the Mode button to select Portrait Mode ().



Panorama Mode

Panorama Mode allows you to create a panoramic picture. The camera will automatically compose a panoramic picture using the individual shots that you take.

Follow these easy steps to create a panoramic picture:

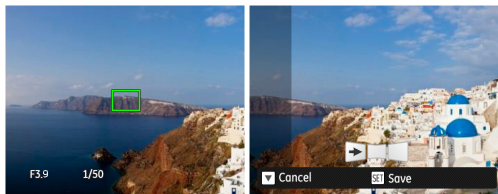
1. Press the **MODE** button to select Panorama Mode (.
2. Press the arrow buttons to select a desired shooting direction. Should you not select a direction, the default shooting direction is "right." 2 seconds later, the camera will be ready to take pictures. You can also press the **SET** button or press the shutter button halfway down to get ready to take panoramic pictures.
3. Compose the first view of the panoramic picture on the LCD and press the Shutter button to capture the image.
4. After the first shot is taken, the semi-transparent image of the first shot will appear at the edge of the screen. You can use this image to compose and align your next picture before you press the shutter button to capture and finish manual stitching.



5. If continuous pictures are less than 4 shots, press the **SET** button, the camera will automatically stitch the pictures together. Press the Playback button to enter Playback Mode to see the finished effect.
 6. If you take 4 pictures, the camera will stitch the pictures together automatically. Press the Playback button to enter Playback Mode to see the finished effect.
-  In Panorama Mode, the Flash, Self-Timer, Macro Modes and Exposure Compensation are not available. Focus Adjustment is also not available at this time.
-  In Panorama Mode, up to 4 photos can be captured when the image size is set at 2M.



During Panorama Mode shooting, press the **SET** button to interrupt shooting and save the current pictures. Press the down button () to cancel shooting and delete previously taken pictures.







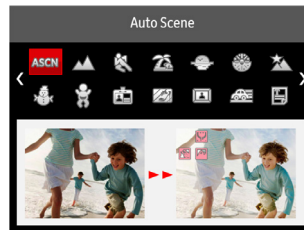





Scene Mode (SCN)









You can select your desired scene from the 21 preset modes according to the type of environment you are shooting in. The camera then automatically configures the most appropriate settings for the best possible photos.

Press the **MODE** button to enter Scene Mode. The LCD will display a menu like the example below:



Press the arrow buttons to select a scene and press the **SET** button to confirm.







Scene	Description
 Auto Scene	Identifies the scene automatically; Person, Backlighting, Landscape, Macro, Night Scene, Night Scene Person and Auto.
 Landscape	For landscapes and outdoor shots. Vivid reproduction of greens and blues.
 Sport	For fast-moving subjects. Captures sharp, action shots with minimal blur. This mode is not recommended for shooting indoors.
 Beach	For taking pictures in areas with strong sunlight.
 Sunset	For sunsets. Captures subjects in strong sunlight.
 Fireworks	For fireworks at night. Use of a tripod is recommended with this setting.
 Night Landscape	For night scenes. Use of a tripod is recommended with this setting.
 Snow	For snowy conditions. Reproduces natural, clear, white scenes.
 Children	Turns flash off automatically. Avoids disturbing the subject and is suitable for taking photos of children and pets.
 ID	For shooting ID size photos. (It is recommended to print using 6-inch 4R (4" X 6") photographic paper).
 Glass	For objects behind transparent glass.
 Photo Frame	For adding interesting frame effects to the photo.

Scene	Description
 Panning Shot	Suitable for capturing fast moving objects to have a clear subject with a blurred background.
 Text	For taking pictures of text, documents or white boards.
 Fish Eye	For an interesting fish eye effect.
 Party	Suitable for taking indoor party pictures, even under complicated lighting conditions.
 Indoor	For indoor settings. Reduces blur and improves color accuracy.
 Leaf	For plants. Captures brilliant shots of greenery and blossoms.
 Museum	For museums or flash-free areas. Retains color and reduces blur.
 Night Portrait	For portraits against night scenery.
 Sketch	For taking photos with pencil sketch effect.

Auto Scene Mode (ASCN)

In “ASCN” Scene Mode, the camera can intelligently detect different environments and automatically select the best scene and photo settings for you.

“ASCN” can intelligently detect the following scenes:

Mode Name	Description
 Landscape Mode	For landscapes, automatically adjusts the exposure and reproduces vivid green and blue colors.
 Portrait Mode	Most suitable for capturing people with focus on their faces.
 Night Portrait	When you take portraits at night, or in low light conditions, automatically adjusts the exposure for people and night scenes.
 Backlit Portrait	When the sun or any other light source is behind you, automatically adjusts the foreground exposure to produce the best pictures possible.
 Night Landscape Mode	For night scenes, automatically increases the ISO value to compensate for low light.
 Macro Mode	The macro setting is ideal for shooting small objects or close-up photos.
 Auto Mode	The camera automatically adjusts the exposure and focus to ensure the best possible pictures.

To use "ASCN":

1. Press the **MODE** button to select "SCN" Mode, then select "ASCN" Function. LCD will be shown as follows:

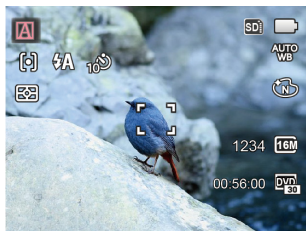

2. Hold the camera steadily and aim at the subject. The optimum scene mode will be selected automatically.
3. Press the shutter button half-way down to focus.
4. Press the shutter button all the way down to take pictures.

Movie Mode

1. Press the **MODE** button to select Movie Mode ().

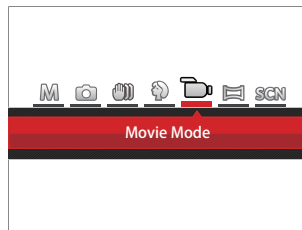

2. Press down the Shutter Button to start recording.
3. Once you are finished, press the Fast Video Recording Button or the Shutter Button to stop recording and return to the shooting screen.

BASIC OPERATION

Using the Zoom Function

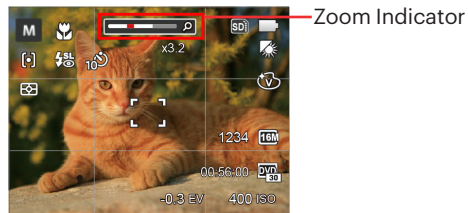
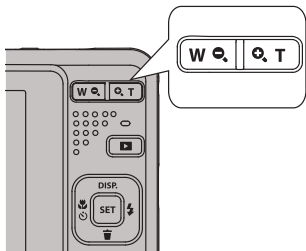

Your camera is equipped with two types of Zoom Functions: Optical Zoom and Digital Zoom. Press the Zoom button of the camera to zoom in or out on the subject while taking pictures.



When the optical zoom reaches the threshold as digital zoom, release and turn the zoom button to T to switch between the optical zoom and digital zoom.



Macro Mode

The Macro Setting is ideal for shooting small objects or close-up photos. This mode allows you to focus on subjects very close to the camera.

1. Press the left arrow button ( ) to enter the Macro Menu.





2. Press the left/right arrow buttons to select the following 2 modes:

-  Macro Off
Select this option to disable Macro.
-  Macro On
Select this to focus on subjects 5cm from the lens.

3. Press the  button to confirm the settings and exit the menu.



Self-Timer Setting

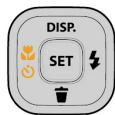

Use this function to take pictures at pre-set intervals. The camera shutter speed can be set to 2 seconds, 10 seconds or Smile Detection.

1. Press the left arrow button () and then press the down () button to enter the Self-Timer Menu.







2. Press the left/right arrow buttons to select one of the following 4 modes:

-  Self-Timer Off
Disables the Self-Timer.
-  Self-Timer 2 sec
A single picture is shot 2 seconds after the Shutter Button is pressed.

-  Self-Timer 10 sec
A single picture is shot 10 seconds after the Shutter Button is pressed.
-  Self-Timer Smile
Press the Shutter Button and a picture will be taken immediately after a smile is detected.

3. Press the  button to confirm the settings and exit the menu.



-  When enabling the Self-Timer feature, pressing the shutter or the () button can disable the Self-Timer and return to the shooting screen without keeping the Self-Timer setting.
-  When enabling smile detection, pressing the shutter or the  button can disable the Self-Timer and return to the shooting screen without keeping the Self-Timer Smile Setting.





Flash Mode

The flash provides supplemental light for scenes. The flash is usually used when shooting against the light to highlight the object; it is also suitable for metering and shooting in darker scenes to improve the exposure.

1. Press the right arrow button () to enter the Flash Settings Menu.



2. Press the left/right arrow buttons to select one of the following 6 modes:
 -  Force Off
Flash is turned off.
 -  Flash Auto
Camera flash goes off automatically based on lighting conditions.

-  Fill Flash
The flash will engage with each shot even if there is enough available light to take the photo without flash.
 -  Slow Sync
This allows you to take pictures of people at night that clearly show both your subjects and the night time backdrop. The use of a tripod is recommended when shooting with this setting.
 -  Slow Sync + Red-Eye
Use this mode for slow synchrony shots with red-eye reduction.
 -  Red-Eye Reduction
The camera emits a brief pre-flash before the picture is taken to reduce red-eye effects.
3. Press the  button to confirm the settings and exit this option.

EV Setting

The EV Function Menu of the camera includes functions, such as EV, Shutter Adjustment and ISO. Using the appropriate Function Settings can improve your pictures.

To select the best setting for optimum photos, follow these steps:

1. Press the **SET** button to display the Settings screen.
2. Press the left/right arrow buttons to select the Setting options.



3. Press the up/down arrow buttons to adjust the option values.
4. Press the **SET** button to complete the setting and enter Shooting Mode.

Exposure Compensation

Set up Exposure Compensation to adjust the picture brightness. If there is very high contrast between the photographed object and the background, the brightness of the picture can be adjusted as necessary. (This can be adjusted in **M** Mode)

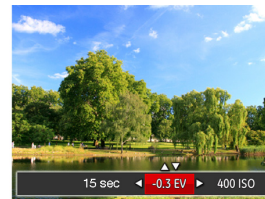
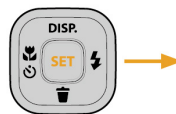

The adjustable range of exposure value is from EV -2.0 to EV+2.0.

ISO

The ISO Function allows you to set the sensitivity of the camera's light sensor based on the brightness of the scene. To improve the camera's sensor performance in darker environments, a higher ISO value is required. A lower ISO value is needed when shooting in brighter conditions.

Pictures taken at higher ISO settings will generally have more noise than those taken at lower ISO settings. (This can be adjusted in  Mode)



The camera's ISO settings include: Auto, 80, 100, 200, 400, 800 and 1600.

Shutter Adjustment

For shutter speed, the camera may automatically set the aperture value corresponding to the manually set shutter speed to obtain the most suitable exposure value. The movement of objects may be shown by adjusting the shutter speed. High shutter value can help you more clearly capture fast moving objects, while low shutter value can better show the movement of objects. (This can be adjusted in  Mode)

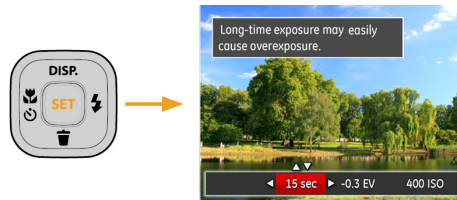

Using Quick Recording



In the Photo Shooting Mode, press the Quick Video Recording Button  to begin recording video.



Once you are finished, press the Quick Video Recording Button or the Shutter Button to stop and store the video. The camera will return to the Shooting Mode automatically.

Viewing Photos and Videos

To view captured photos and video clips on the LCD:

1. After pressing the  button, the last photo or video clip taken will be displayed on the LCD.
2. Use the left/right navigation buttons to scroll through the photos or video clips stored on the built-in memory or on the Memory Card in the camera.
3. To play a selected video clip, press the  button to enter the Movie Playback Mode.

An operation guide appears on the screen when playing back a video. Press the appropriate buttons to enable the corresponding functions.

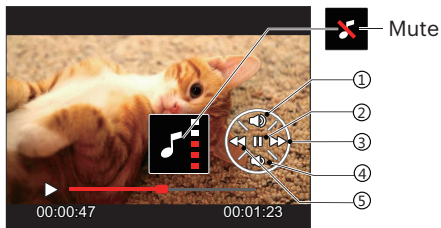

1	Increase Volume
2	Pause
3	Fast Forward
4	Decrease Volume
5	Rewind

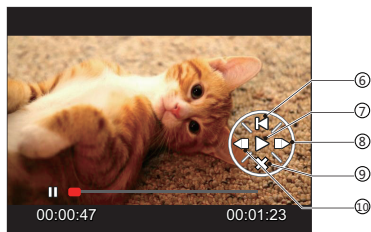

6	Return back to the beginning of the video
7	Play
8	Frame Forward
9	Cancel Playback
10	Frame Backward

Thumbnail View



When in Playback Mode, press the **W**  on the Zoom button to display thumbnail images of photos and videos on the screen.

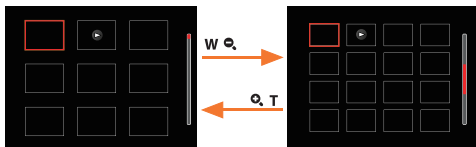

1. Slide the Zoom button to switch between 3 x 3 and 4 x 4 thumbnails.
2. When a 3 x 3 or 4 x 4 thumbnail is displayed, press the arrow buttons to select the picture or video clip to view.



3. Press the arrow buttons to select a picture or video clip to view and press the **SET** button to restore it to the original size.

 If the  indicator appears on the LCD, then a movie file is currently being displayed.

 Press the **SET** button to restore a preview icon to its original image size.

Using Zoom Playback (for still pictures only)

When playing back photos, you can also use the Zoom Button to zoom in on the photos, 2 to 8 times their original magnification.



1. Press the left/right buttons to select the picture on which to use the zoom feature.
2. Press the **+** **T** on the Zoom Button to zoom in.
3. The bottom right corner of the screen will display the amount zoomed in as well as the area of the photo shown.

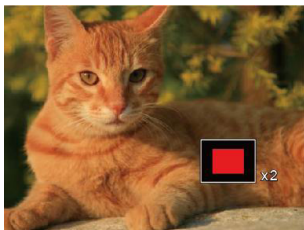



4. Press the arrow buttons to navigate and select the desired portion of the photo to be zoomed in on.
5. Press the **SET** button to return the image to its original scale.

 Movie images cannot be magnified.

Slideshow

This setting allows you to view all the stored pictures as a slideshow.

1. Press the  button to enter playback screen.
2. Press the  button to enter slide option.
3. Press the left/right buttons to select slideshow playing or [Cancel] to return to the playback screen.

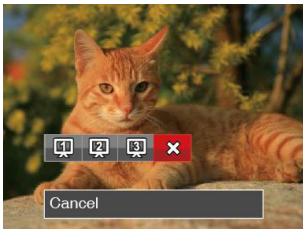

4. Press the  button to confirm the setting.

Photos and Video Deletion

In Playback Mode, press the down arrow button (⏏) to select your desired photos and videos.

To delete photos or videos:

1. Press the (▶) button to switch to Playback Mode.
2. Press the left/right arrow buttons to select the photos and videos to be deleted.
3. Press the down arrow button (⏏) and the deletion screen is displayed.

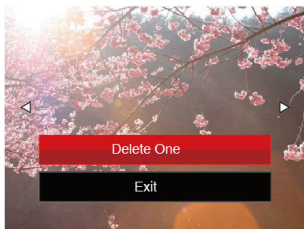

4. Press the up/down arrow buttons to select [Delete One] or [Exit] and press the (SET) button to confirm.



Erased photos/video clips cannot be recovered.





Please refer to page 63 for instructions on deleting more than one image at a time.

USING THE MENUS

Photo Setup Menu

Mode:     **SCN**

1. In Photo Shooting Mode, press the  button to enter the Photo Shooting Menu.
2. Press the up/down arrow buttons to select the Photo Shooting Menu and settings.
3. Press the left/right arrow buttons to select the Photo Shooting Menu to be set and press the  button to confirm.



Refer to the following pages for more details about each setting.

Expo Metering (Exposure Metering)

Use this setting to select the "target" size of the camera's field of view to be metered.



There are 3 options:

- **AiAE (Artificial Intelligence AE):** Automatically selects the central and peripheral metering, to calculate the reasonable value of metering by weighting.
- **Spot metering** targets a small area in the center of the camera's field of view.
- **Center metering** targets a slightly larger area in the center of the camera's field of view.

Image Size

The size setting refers to the image resolution in pixels. A higher image resolution allows you to print that image in larger sizes without degrading the photo image quality.

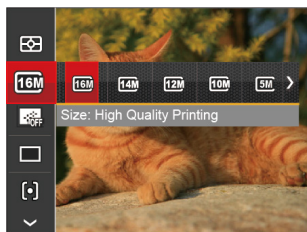

The bigger the number of recorded pixels is, the better the image quality becomes. As the number of recorded pixels lessens, you will be able to record more images on a memory card.

Continuous AF

Use the Continuous AF setting to be able to continuously focus automatically when taking pictures.

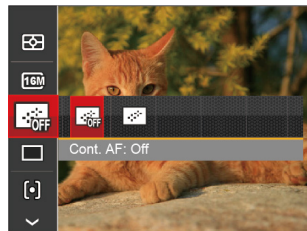

There are 2 options:

- Off
- On

Continuous Shot

Use this setting to perform continuous shooting. After entering this mode, you can shoot multiple images by continuously holding the shutter button down.



There are 7 options:

-  Single
-  Continuous Shot
-  3 Shots

-  Time-Lapse 30sec
-  Time-Lapse 1min
-  Time-Lapse 5min
-  Time-Lapse 10min

 The flash is disabled in Continuous Shot Mode in order to achieve quick succession of shots.



 Press the shutter button to start continuous shooting.

Focus Setting

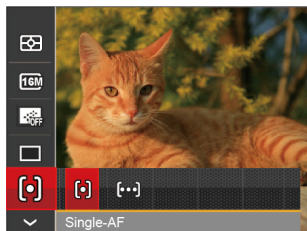
This setting allows you to select different modes for optimum focus.



There are 2 options:







-  Single-AF: The focus frame appears on the center of the LCD to help you focus on the subject.
-  Multi-AF: The camera automatically focuses the subject in a wider area to find the focal point.

White Balance Setting

The white balance setting allows you to adjust the color temperature for different lighting scenes to ensure the most accurate color reproduction.



There are 7 options:

-  AUTO WB AWB
-  Daylight
-  Cloudy
-  Fluorescent
-  Fluorescent CWF
-  Incandescent
-  Manual WB (Fully press the Shutter Button to detect the white balance value)



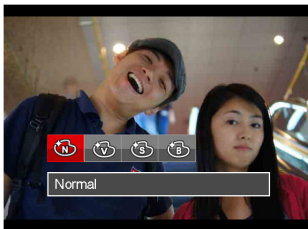

Color Effect

The image color setting allows you to select different color effects.

1. Press the **SET** button to select the image color setting menu.
2. Press the left/right arrow buttons to select the image color setting options.



There are 4 options:

-  Normal
-  Vivid
-  Sepia
-  Black and White

• Options in the shooting mode (O: Available X: Unavailable)















Options	Shooting Modes						
	M						SCN
	O	O	O	O	O	X	O
	O	O	X	O	X	X	O
	X	X	X	X	O	X	X
	O	O	X	O	X	X	X
	O	O	X	O	X	X	X
	O	O	X	X	X	X	X
	O	X	X	X	X	X	X
	O	X	X	X	O	X	X
	X	X	X	X	X	X	O

Photo Shooting Setting Menu

Mode: **M** **SCN**

1. Press the button in Photo Shooting Mode and press the up/down buttons to select .

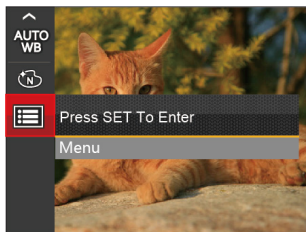

2. Press the button to enter the menu.
3. Press the up/down arrow buttons to select and press the button or right arrow button to enter the menu.
4. Press the up/down arrow buttons to pick the item to be selected and press the button or right arrow button to enter the menu.
5. Press the up/down arrow buttons to select an option and press the button to confirm.

Quality

The quality setting can be used to adjust the image compression ratio.

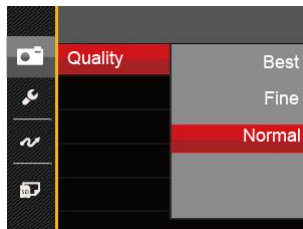

There are three options for picture quality:

- Best (16M Average File Size: 4.0MB)
- Fine (16M Average File Size: 2.5MB)
- Normal (16M Average File Size: 2.0MB)

AF Assist Beam

In a darker environment, the AF assist beam setting can be turned on for better focus.



Digital Zoom

This setting is for adjusting digital zoom. If this function is disabled, only optical zoom can be used.

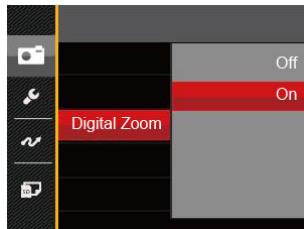

Date Imprint

Include a Date/Time stamp on the photo image.

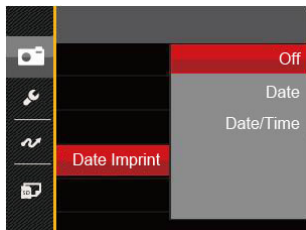

- Off
- Date
- Date/Time

Quick Review

This option allows quick review of the photos immediately after they are taken. Each photo is displayed on the LCD screen based on the selected time.

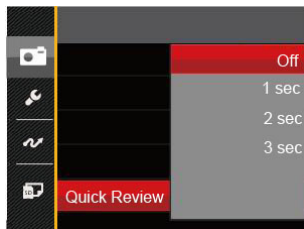



There are 4 options:

- Off
- 1 sec
- 2 sec
- 3 sec

Movie Menu

Mode: 

1. Press the  button, select the  mode and press the  button to enter the Movie Menu.

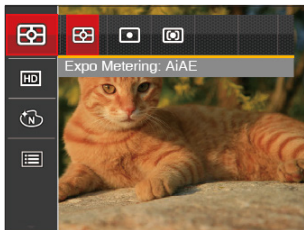

2. Press the up/down arrow buttons to select the Movie Menu to be set.
3. Press the left/right arrow buttons to select the Movie Menu to be set and press the  button to confirm.

Expo Metering (Exposure Metering)

Use this setting to select the "target" size of the camera's field of view to be metered.



There are 3 options:

- **AiAE (Artificial Intelligence AE):**
Automatically selects the central and peripheral metering, to calculate the reasonable value of metering by weighting.
- **Spot metering** targets a small area in the center of the camera's field of view.
- **Center metering** targets a slightly larger area in the center of the camera's field of view.

Video Quality

Set the image resolution used during video recording.

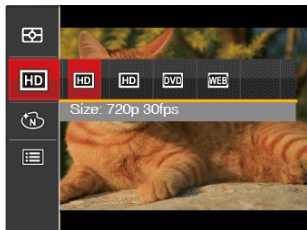

The speed requirements for reading and writing high resolution image pixel images to an SD card are as follows:

No.	Image Pixels	Frames	Recommendation	Recording Time (4GB) About
1	1280 x 720 *	30	Class 4	16 Minutes
2	1280 x 720	15	Class 4	32 Minutes
3	640 x 480	30	Class 4	48 Minutes
4	320 x 240	30	Class 4	201 Minutes



* The longest recording time is 29 minutes at one time.



When recording in higher pixel resolutions for extended periods of time, this can cause the camera to generate heat. This is not a camera malfunction.



Color Effect

The Image Color Setting allows you to select different color effects.

1. Press the **SET** button to select the Image Color Setting Menu.
2. Press the left/right arrow buttons to select the image color setting options.





There are 4 options:

-  Normal
-  Vivid
-  Sepia
-  Black and White

Movie Setting Menu

Mode: 

1. Press the **MODE** button, and select  to enter the video recording screen.
2. Press the  button and press the up/down arrow buttons to select . Press the **SET** button to enter the menu.



3. Press the up/down arrow buttons to select  and press the **SET** button or right arrow button to enter the menu.
4. Select the items to be set and press the **SET** button or the right arrow button to enter the menu.
5. Press the up/down arrow buttons to select an option and press the **SET** button to confirm.



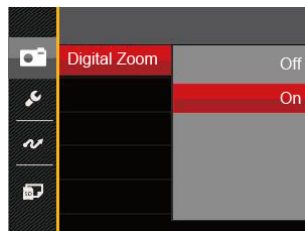

Digital Zoom

This setting is for adjusting digital zoom. If this function is disabled, only optical zoom can be used.



Playback Menu

Mode: 



1. Press the  button to display the playback screen and press the  button to enter the menu.
2. Press the up/down arrow buttons to select the playback desired and press  button to enter.
3. Press the left/right arrow buttons to select an option and press the  button to confirm.





Refer to the following pages 59 to 61 for more details about each setting.

HDR

With the HDR function, pictures that are overexposed may be corrected to optimize the highlights and lowlights captured to more accurately represent the actual scene.

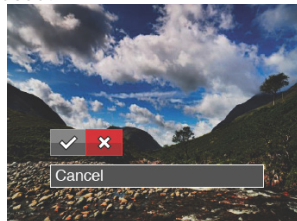
1. In Playback Mode, press the left /right arrow buttons to select the photos to be edited.
2. Press the  button, select the  settings, and press the  button to display the settings screen.
3. Press the left/right buttons to select whether HDR is used.





 : HDR  : Cancel

4. After using the HDR function, the image will be saved as a new file and the original file is still stored in the memory.

Red-Eye Reduction

You can use this setting to reduce the red-eye of the picture.

1. In Playback Mode, press the left /right arrow buttons to select the photos to be edited.
2. Press the  button, select the  settings, and press the  button to display the settings screen.
3. Press the left/right arrow buttons to select the corresponding menu or [Cancel] to return to the playback screen.

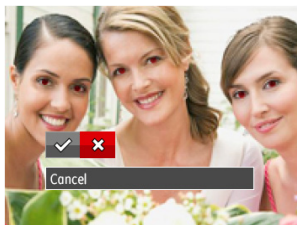



-  : Red-Eye Reduction
-  : Cancel

4. Press the  button to confirm the setting.



Rotate

You can use this setting to change the orientation of the picture.

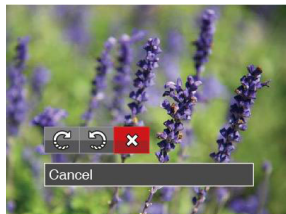
1. In Playback Mode, press the left /right arrow buttons to select the photos to be edited.
2. Press the  button, select the  settings, and press the  button to display the settings screen.
3. Press the left/right arrow buttons to select the rotation direction or [Cancel] to return to the Playback Menu.





-  : Turn Right
-  : Turn Left
-  : Cancel

4. Press the  button to confirm the setting.
-  Videos and panoramic pictures cannot be rotated.
 -  The rotated picture file will replace the original photo.

Resize

This setting allows you to resize a picture to a particular resolution and saves it as a new picture.

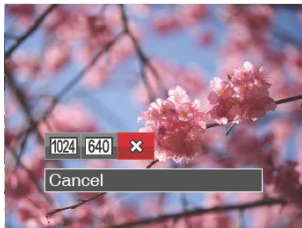

1. In Playback Mode, press the left /right arrow buttons to select the photos to be edited.
2. Press the  button, select the  settings and press the  button to display the settings screen.
3. Press the left/right arrow buttons to select [1024X768] or [640X480] or select [Cancel] to return to the Playback Menu.





4. Press the  button to confirm the setting.

Color

This setting allows you to change the picture color effect. The file is saved as a new photo and stored in memory together with the original photo.

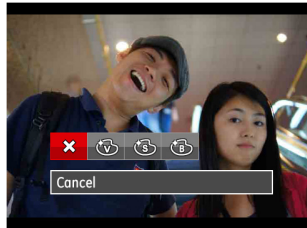
1. In Playback Mode, press the left /right arrow buttons to select the photos to be edited.
2. Press the  button, select the  settings, and press the  button to display the settings screen.
3. Press the left/right arrow buttons to select the corresponding menu or [Cancel] to return to the playback screen.



4. Press the  button to confirm the setting.

 : Cancel





 : Sepia

 : Vivid





 : Black and White

Playback Setting Menu

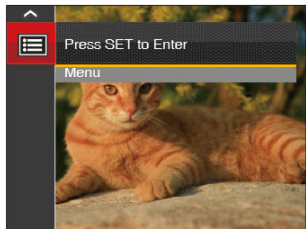
Mode: 

1. Press the  button to show the playback screen, press the  button, and press the up/down arrow buttons to select .
2. Press the  button to enter the menu.



3. Press the up/down arrow buttons to select  and press the  button or right arrow button to enter the menu.
4. Press the up/down arrow buttons to select the item to be set and press the  button or right arrow button to enter the menu.
5. Press the up/down arrow buttons to select an option and press the  button to confirm.

Refer to the following pages for more details about each setting.

Protect

To prevent any pictures or videos from being accidentally erased, use this setting to lock one or all of the files.

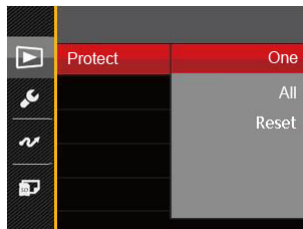

To lock or unlock the photo and video files:

1. Press the up/down arrow buttons to select [Protect] and press the  button or right arrow button to enter the sub-menu.

2. Press the up/down arrow buttons to select the sub-menu and press the **(SET)** button or right arrow button to show the settings screen.

There are 3 sub menus available:

- One: Lock the selected photo or video if they are unprotected; unlock the selected photo or video if they are protected.
 - All: Lock all photos or videos.
 - Reset: Cancel all locked photos or videos.
3. Press the up/down arrow buttons to select an option and press the **(SET)** button to confirm.

Delete

You can delete one or all photo/video files.

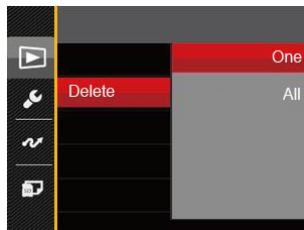

To delete photo or video files:

1. Press the up/down arrow buttons to select [Delete] and press the **(SET)** button or right arrow button to enter the sub menu.
2. Press the up/down arrow buttons to select the submenu and press the **(SET)** button or right arrow button to show the settings screen.

There are 2 sub menus available:

- One: Delete one photo or video.
- All: Delete all photos or videos.

3. Press the up/down arrow buttons to select an option and press the **SET** button to confirm.

 The “**Ⓢ**” indicator means a file is protected. File protection must be removed before a file can be deleted.

 Deleting files will cause DPOF settings to be reset.

 Deleted files will be permanently deleted and will not be able to be recovered or restored.

DPOF (Digital Print Order Format)

The DPOF feature allows you to compile and select a group of pictures that you would like to print and will save your selection on the memory card so that you can use the memory card to print without having to individually specify the photos you want to print.

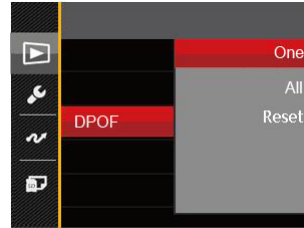





 A printer that supports DPOF is needed for photo printing.

Trim

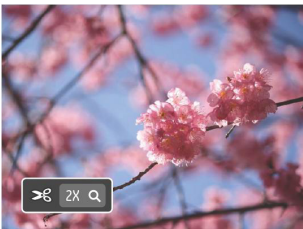
The Trim setting allows you to crop photos and save them as new pictures.

1. Press the up/down arrow buttons to select [Trim] and press the  button or right arrow button to enter the menu.
2. Select [Yes] to confirm trim. Select a section of the photo to be trimmed using the zoom button and arrow buttons to trim a photo.







3. Press the  button and the [Save change?] prompt appears. Select [] to change and save the picture. Select [] to cancel changes and return to the trim prompt screen.





The image cannot be clipped/trimmed again once it has been clipped to 640 X 480.

Setup Menu

Mode :        

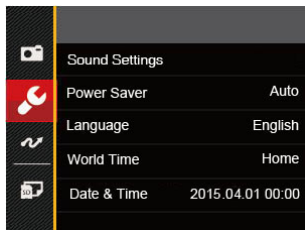
1. Press the  button in any mode and press the up/down buttons to select .
2. Press the  button to enter the menu.
3. Press the up/down arrow buttons to select  and press the  button or right arrow button to enter the menu.



4. Press the up/down arrow buttons to select the item to be set and press the  button or right arrow button to enter the menu.
5. Press the up/down arrow buttons to select an option and press the  button to confirm.

Refer to the following pages for more details about each setting.

Sound Settings

To change this setting:

1. Select [Sound Settings] in the basic settings menu. Press the  button or right arrow button to enter the menu.
2. Press the left/right arrow buttons to select an option.

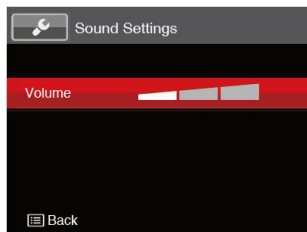



3. Press the  button to confirm.

Power Saver

This setting allows you to save power and get the maximum possible running time for your camera's batteries. Follow the steps below to turn the LCD and camera off automatically after a consecutive period of inactivity.

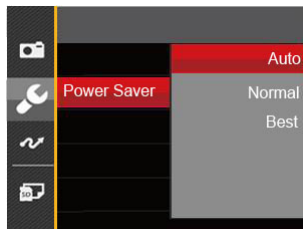
1. Select [Power Saver] in the basic settings menu. Press the button or right arrow button to enter the menu.
2. Press the up/down arrow buttons to select an option.





3. Press the  button to confirm.

Language

Refer to the "Resetting your Language" section on page 19.

World Time

The Zone setting is a useful function for your overseas trips. This feature enables you to display the local time on the LCD while you are abroad.

1. Select [World Time] in the basic settings menu. The World Time screen appears.
2. Press the up/down arrow buttons to select the departure place () and destination () fields.
3. Press the left/right arrow buttons to select a city located in the same time zone as that of the field. Press the  button to confirm settings.

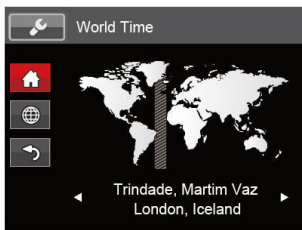







Date & Time

Refer to the “Resetting Date/Time” section on page 20.

Format

Please Note: formatting enables you to delete all contents on the memory card and camera’s built-in memory, including protected photo and movie files. To use this setting:

1. Press the  button, press the up/down arrow buttons to select  and press the  button to enter the menu.
2. Press the up/down arrow buttons to select  and press the  button or right arrow button to enter the menu.
3. Press the up/down arrow buttons to select [Format] and press the  button or right arrow button to enter the menu.
4. Press the up/down arrow buttons to select [Yes] or [No] and press the  button to confirm.

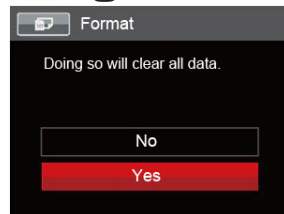







5. If you select [Yes] the camera will format its memory.



If there is no memory card in the camera, the built-in memory will be formatted; if there is a memory card, only the memory card will be formatted.

Copy to Card

Use this setting to copy the files stored in the camera's built-in memory to a memory card.



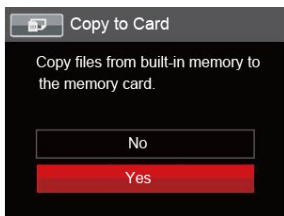



1. Press the  button, press the up/down arrow buttons to select  and press the  button to enter the menu.
2. Press the up/down arrow buttons to select  and press the  button or right arrow button to enter the menu.
3. Press the up/down arrow buttons to select [Copy to Card] and press the  button or right arrow button to enter the menu.
4. Press the up/down arrow buttons to select [Yes] or [No] and press the  button to confirm.



If there is no card available in the camera, this function will not be displayed.

File Numbering





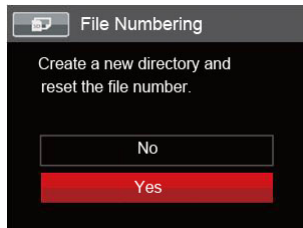

After you take a picture or video clip, the camera will automatically save it with a sequential number. You can use this to reset the file numbering to 1.

1. Press the  button, press the up/down arrow buttons to select  and press the  button to enter the menu.
2. Press the up/down arrow buttons to select  and press the  button or right arrow button to enter the menu.
3. Press the up/down arrow buttons to select [File Numbering] and press the  button or right arrow button to enter the menu.
4. Press the up/down arrow buttons to select [Yes] or [No] and press the  button to confirm.



Reset





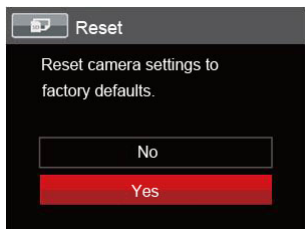

Use this setting to restore the camera to its original factory default settings.

1. Press the  button, press the up/down arrow buttons to select  and press the  button to enter the menu.
2. Press the up/down arrow buttons to select  and press the  button or right arrow button to enter the menu.
3. Press the up/down arrow buttons to select [Reset] and press the  button or right arrow button to enter the menu.
4. Press the up/down arrow buttons to select [Yes] or [No] and press the  button to confirm.



Firmware (FW) Version

Use this setting to view the current camera firmware version.

1. Press the  button, press the up/down arrow buttons to select  and press the  button to enter the menu.
2. Press the up/down arrow buttons to select  and press the  button or right arrow button to enter the menu.
3. Press the up/down arrow buttons to select [FW Version] and press the  button or right arrow button to enter the menu.



4. When there is a new firmware version in the SD card, select [Yes] to update.







CONNECTIONS

Connecting to a Computer

You can use a USB cable to connect the camera and copy (transmit) photos to a computer, printer or other device.

Setting the USB Mode

The camera's USB port can be used to connect to either a computer or a printer. The following steps will allow you to ensure that the camera is correctly configured to connect with a PC.

1. Press the  button, press the up/down arrow buttons to select  and press the  button to enter the menu.
2. Press the up/down arrow buttons to select  and press the  button or right arrow button to enter the menu.
3. Press the up/down arrow buttons to select [USB] and press the  button or right arrow button to enter the menu.
4. Press the up/down arrow buttons to select [PC] and press the  button to confirm.



Transferring Files to Your Computer

The computer will automatically detect the camera as a removable drive. Double-click the "My Computer" icon on the desktop to locate the removable drive and to copy folders and files in the drive to a directory on your PC as you would copy any typical folder or file.

Follow the steps below to connect the camera to a computer:





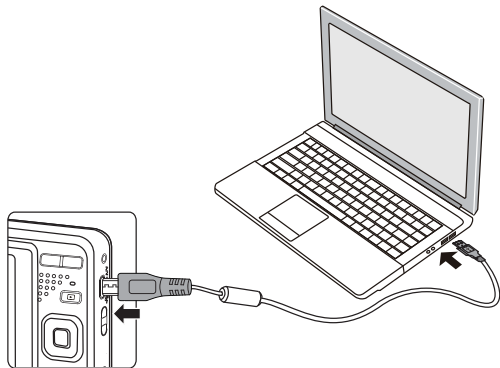

1. Make sure both the camera and computer are turned on
2. Connect one end of the supplied USB cable to the USB/AV port on your camera

3. Connect the other end of the cable to an available USB port on your computer
4. After the transmission is complete, disconnect the USB cable according to your computer manufacturer's instructions specifying how to safely remove USB devices.



Video System

You can use an AV cable (which should be purchased separately) to connect the camera to a television for viewing the video output. Connect one end of the AV cable to the USB/AV port of the camera, connect the other end to the AV-OUT port of the television. Adjust the format of the video output system according to your specific requirements, and follow the steps below:

1. Press the  button, press the up/down arrow buttons to select  and press the  button to enter the menu.
2. Press the up/down arrow buttons to select  and press the  button or right arrow button to enter the menu.
3. Press the up/down arrow buttons to select [TV-System] and press the  button or right arrow button to enter the menu.
4. Press the up/down arrow buttons to select [NTSC] or [PAL] and press the  button to confirm.

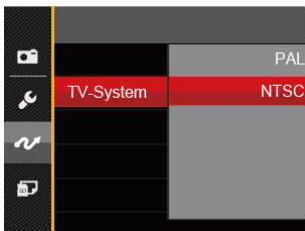







NTSC: English, Chinese (Traditional), Japanese, Korean, Vietnamese

PAL: German, Spanish, Italian, Chinese (Simplified), Portuguese, Swedish, Danish, Finnish, Indonesia, Norwegian, Dutch, Turkish, Polish, Thai, Croatian, Czech, Arabic, Hindi, French, Russian, Greek, Hungarian

Set Eye-Fi SD Card Connection Mode

This camera supports wireless connection of an Eye-Fi SD Card. Enable Eye-Fi connection by following below steps:

1. Press the  button then press the up/down arrow buttons to select . Press the  button to enter the menu.
2. Press the up/down arrow buttons to select  and press the  button or right arrow button to enter the menu.
3. Press the up/down arrow buttons to select [Eye-Fi] and press the  button or right arrow button to enter the menu.
4. Press the up/down arrow buttons to select [On] or [Off] and press the  button to confirm.

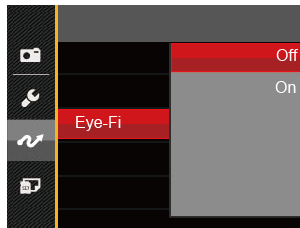

 If the Eye-Fi card is not available in the camera, this feature is not displayed.

Connecting to PICTBRIDGE™ Compatible Printers









PICTBRIDGE™ technology allows printing of the photos saved on the memory card by a printer.

To find out if a printer is PICTBRIDGE™ compatible, simply look for the PICTBRIDGE™ logo on the packaging or check the owner's manual for specifications. With the PICTBRIDGE™ function on your camera, you can print the captured photos directly to a PICTBRIDGE™ compatible printer using the supplied USB cable, without the need for a PC.



Setting the USB Mode

The camera's USB port can be set to connect with either a PC or a printer. The following steps will ensure that the camera is correctly configured to connect with a compatible printer.

1. Press the  button, press the up/down arrow buttons to select  and press the  button to enter the menu.
2. Press the up/down arrow buttons to select  and press the  button or right arrow button to enter the menu.

3. Press the up/down arrow buttons to select [USB] and press the  button or right arrow button to enter the menu.
4. Press the up/down arrow buttons to select [Printer] and press the  button to confirm.



-  After the camera is reset, it will switch to PC mode automatically from USB Mode.
-  See "Using the PICTBRIDGE™ Menu" section on page 76.

Connecting to your Printer

1. Make sure both the camera and printer are turned on.
2. Connect one end of the supplied USB cable to the USB port on your camera.
3. Connect the other end of the cable to the USB port on the printer.

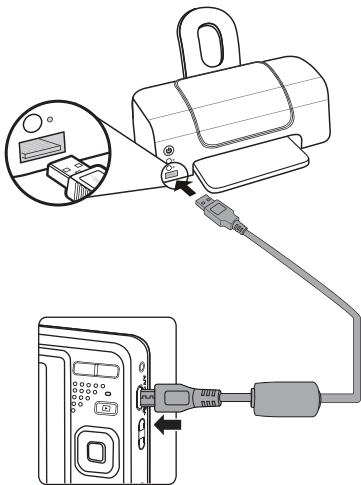

If the camera is not connected to a PICTBRIDGE™ compatible printer, the following error message will appear on the LCD.

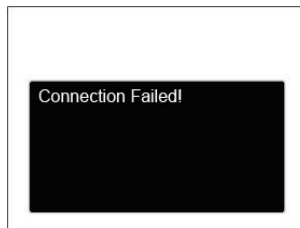

-  The error message above will also appear if the USB Mode is set incorrectly, in which case you should disconnect the USB cable, check the USB Mode settings, ensure that the printer is turned on, and then try connecting the USB cable again.

Using the PICTBRIDGE™ Menu

After setting the USB mode to Printer, the PICTBRIDGE™ menu will appear.



Press the up/down arrow buttons to select a menu item and press the  button or right arrow button to enter the item.

Refer to the following sections for more detailed information on each setting.

Print (with Date)

If you have set the date and time on your camera, the date and time will be recorded and saved with each photo you take.

1. In the PICTBRIDGE™ menu, select [Print (with Date)] and the screen as shown below appears.

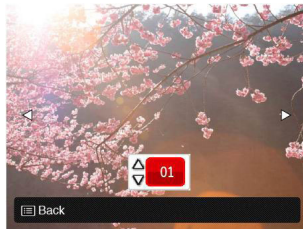

2. Press the left/right arrow buttons to select a photo to be printed.

3. Press the up/down arrow buttons to select the number of copies for the currently displayed photo.
4. Press the **SET** button and the following screen will appear.

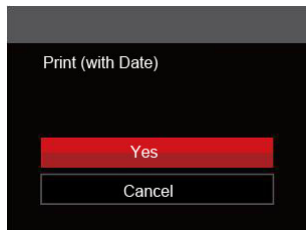

5. Select [Yes] and press the **SET** button to confirm; select [Cancel] to cancel printing.

Print (without Date)

Use this setting to print the photos without dates on them.

1. In the PICTBRIDGE™ menu, select [Print (without Date)] and the screen as shown below appears.

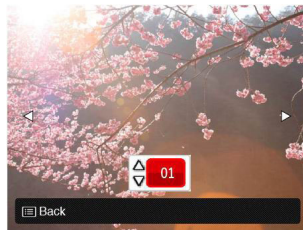

2. Press the left/right arrow button to select the photo to be printed.
3. Press the up/down arrow buttons to select the number of copies for the currently displayed photo.
4. Press the **SET** button and the following screen will appear.

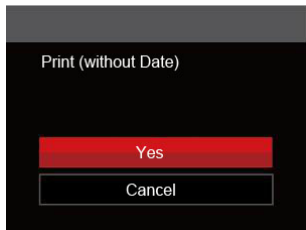



5. Select [Yes] and press the  button to confirm; select [Cancel] to cancel printing.

Print Index

You can print all photos in the camera via this function.

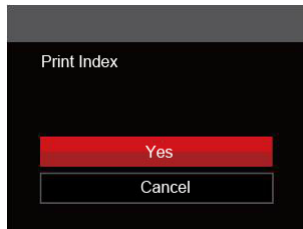
1. In the PICTBRIDGE™ menu, select [Print Index] and the screen as shown below appears.





2. Select [Yes] and press the  button to confirm; select [Cancel] to cancel printing.

Print DPOF Images

To use DPOF printing, you must select your photos for printing using the DPOF settings before hand. See “**DPOF**” section on page 64.

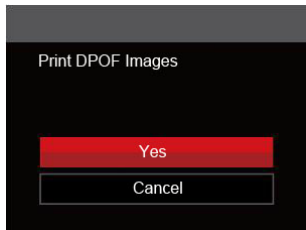
1. In the PICTBRIDGE™ menu, select [Print DPOF Images] and the screen as shown below appears.



2. Select [Yes] and press the  button to confirm; select [Cancel] to cancel printing.

Exit

Select [Exit] to exit the PICTBRIDGE™ menu. At this time, the message [Remove USB Cable!] will appear on the screen.



Disconnect the USB cable from the camera and printer.

APPENDICES

Specifications



Design and specifications are subject to change without notice.

Image Sensor	Type	1/2.3"CCD
	Effective Pixels	16.15 Megapixels
	Total Pixels	16.44 Megapixels
Lens	Focal Length	5.1mm (Wide) — 25.5mm (Tele)
	35mm Film Equivalent	28mm (Wide) — 140mm (Tele)
	F Number	F3.9 (Wide) — F6.3 (Tele)
	Lens Construction	8 groups 8 elements
	Optical Zoom	5x
	Focusing Range	Normal: (Wide) 60cm ~ ∞ (Tele) 100cm ~ ∞ Macro: 5cm ~ ∞ (Wide Only)
Autofocus System		TTL Autofocus
Anti-Handshake		Digital Image Stabilization
Digital Zoom		6x Digital Zoom (Combined Zoom: 30x)

Number of Recording Pixels	Still Image	(4:3) 16MP: 4608 × 3456 10MP: 3648 × 2736 5MP: 2592 × 1944 3MP: 2048 × 1536 0.3MP: 640 × 480	(3:2) 14MP: 4608 × 3072	(16:9) 12MP: 4608 × 2592 2MP: 1920 × 1080
	Movie	1280 × 720 (30fps), 1280 × 720 (15fps), 640 × 480 30fps, 320 × 240 30fps		
Image Compression		Best, Fine, Normal		
DCF, DPOF (Ver1.1) Support		Yes		
File Format	Still Image	Exif 2.3 (JPEG)		
	Movie	Movie Format: MOV (Motion JPEG), Audio: G.711 [Monaural]		
Shooting Modes		Manual Mode, Auto Mode, Anti-shake, Portrait, Movie Mode, Panorama Mode, Scene Mode		
Scene Mode		Auto Scene, Landscape, Sport, Beach, Sunset, Fireworks, Night Landscape, Snow, Children, ID, Glass, Photo Frame, Panning Shot, Text, Fish Eye, Party, Indoor, Leaf, Museum, Night Portrait, Sketch		
Detection Features		Face, Smile, Blink		
Red-Eye Removal		Yes		
HDR		Yes (Post-Processing)		

Panorama	Up to 180° (Horizontal)
LCD Display	2.7 inch (230k Pixels)
ISO Sensitivity	Auto, ISO80/100/200/400/800/1600
AF Method	Single AF, Multi-AF (TTL 9-point), Face-Detection
Exposure Metering Method	Artificial Intelligence AE (AiAE), Center-Weighted Average, Spot (Fixed to Center of Frame), Face AE
Exposure Control Method	Program AE (AE-Lock Available)
Exposure Compensation	±2EV in 1/3 Step Increments
Shutter Speed	1/2000 ~ 4 Seconds (Manual: 30 Seconds)
Continuous Shooting	Yes
Playback Modes	Single Photo, Index (9/16 Thumbnails), Slide Show
	Zoom (Approx. x2 ~ x8)
White Balance Control	Auto (AWB), Daylight, Cloudy, Fluorescent, Fluorescent CWF, Incandescent, Manual

Flash	Flash Method	Internal
	Flash Modes	Flash Off, Flash Auto, Forced Flash, Slow Synchro, Slow Synchro + Red-Eye Reduction, Red-Eye Reduction
Recording Media		Internal Memory: Approx. 63MB
		SD/SDHC Card (Up to 32GB Support) [MMC Card not supported]
PICTBRIDGE™, ExifPrint Support		Yes
Multi-Language Support		27 Languages
Jacks		AV-OUT/USB 2.0 (Micro 5 pin USB)
Eye-Fi Support		Yes
Power		Rechargeable Li-ion Battery LB-012, 3.7V 700mAh, In-Camera Charging
Shooting Capability (Battery Performance)		Approx. 200 Shots (Based on CIPA Standards)
Operation Environment		Temperature: 0 ~ 40°C, Humidity: 0 ~ 90%
Dimensions (W×H×D)		Approx. 91.5 × 56.5 × 22.6mm (Based on CIPA Standards)
Weight		Approx. 106g (Body Only)

Prompts and Warning Messages

Message	Description	Action
Warning! Battery exhausted.	The camera battery is depleted. It is a warning indicating that the camera is going to shut off.	Replace with new batteries. The camera will shut down in 2 seconds.
Lens obstruction, Re-start Camera.	The lens is jammed or some foreign object is preventing the lens from functioning properly.	Turn the camera off and restart it to reset the lens.
Suggest using tripod.	When continuous exposure is enabled, this prompt message is displayed when the photo shooting screen is displayed for the first time.	This message will disappear after 2 seconds
Battery temperature is too high.	The battery temperature reaches 53.5 °C.	Let the battery cool before attempting to use the camera again. This message will disappear after 2 seconds
Built-in memory error!	An error has occurred in the internal memory.	Try shutting down the camera and turning it on again. This message will disappear after 2 seconds

Message	Description	Action
Warning! Do not turn off your camera during update!	This message appears during the firmware update process.	This message disappears after the camera update and restart.
Connection Failed!	Failure to connect to your PC, printer, TV.	Remove USB cable and retry connection
Please update firmware after the battery is fully charged!	The firmware cannot be updated when power is insufficient.	A message appears to prompt updating after full charging and returning to the update screen.
Write Protect !	The memory card is locked.	Remove memory card and switch the lever on the side of card to UNLOCK. This message will disappear after 2 seconds.
Card Full !	Indicates that the memory card is full.	Replace memory card with another that has available memory. This message will disappear after 2 seconds.

Message	Description	Action
Memory Full !	Indicates that the camera memory is full.	It will disappear after 2 seconds.
Card Error !	During power-on, the memory card cannot be recognized or a read/write error has occurred.	Format the memory card. WARNING: Formatting the memory card will erase all data on the card. Copy the data from the memory card to another storage, such as a computer. Otherwise, all data will be erased after the format. This message will disappear after 2 seconds.
Card is not formatted.	When an error occurs in the memory card, the message "Not Formatted" will appear.	Format the memory card. WARNING: Formatting the memory card will erase all data on the card. Copy the data from the memory card to another storage, such as a computer. Otherwise, all data will be erased after the format.
Slow access	When a memory card lower than Class 4 is used to record a HD movie, the writing speed will be slower and recording will not continue.	Replace the memory card with a higher Class over 4. This message will disappear after 2 seconds.
Cannot write to SD card.	The photo shooting or video recording has been interrupted, so recording cannot continue.	Turn the camera off. Then unload and reload the memory card and turn on the camera to restart. Also check if memory card is full or in the locked position.
No Red-Eye Detected!	Red eyes have not been detected in the image.	This message will disappear after 2 seconds.

Message	Description	Action
This image cannot be edited.	The file format does not support editing or the edited file cannot be edited again.	This message will disappear after 2 seconds.
Exceeded maximum folder number.	This indicates that the memory card exceeded the maximum number of folders (999). This could cause a long read time during the camera's power up.	Copy the data to your PC and format the memory card using the camera.
Too many pictures for fast processing.	During the playback by date, the images exceed specifications so that it is not possible to play by date.	The message disappears after 2 seconds and the camera returns to normal playback mode.
Unable to recognize files.	The format of the file to be viewed is not supported or the file is corrupted so it cannot be properly read.	This message disappears only after the file is deleted.
No Picture!	When you press the play button, no image files exist in the camera or on memory card.	This message disappears after 2 seconds and returns to the photo shooting screen.
Protected! Undeletable!	The file is protected. The message appears when you go into delete mode.	Remove memory card and switch the lever on the side of card to UNLOCK. Place card back into the camera and try again. This message will disappear after 2 seconds.

Troubleshooting

Problem	Possible causes	Solution
Camera does not turn on	<ul style="list-style-type: none">■ The battery has been depleted.■ The battery is not inserted correctly.	<ul style="list-style-type: none">■ Replace the battery.■ Correctly reinstall the battery.
Camera turns off suddenly during operation	<ul style="list-style-type: none">■ The battery has been depleted.	<ul style="list-style-type: none">■ Replace the battery.
The picture is blurred	<ul style="list-style-type: none">■ Camera movement while taking a picture.	<ul style="list-style-type: none">■ Turn on Anti-shake mode.
Images and video files cannot be saved	<ul style="list-style-type: none">■ The memory card is full.■ The memory card is locked.	<ul style="list-style-type: none">■ Use another memory card or delete unnecessary files.■ Unlock the memory card.
Images will not print from the connected printer	<ul style="list-style-type: none">■ The camera is not connected to the printer correctly.■ The printer is not PICTBRIDGE™ compatible.■ The printer is out of paper or ink.■ The printer paper is jammed.	<ul style="list-style-type: none">■ Check the connection between the camera and printer.■ Use a PICTBRIDGE™ compatible printer.■ Load paper into the printer or replace the ink cartridge in the printer.■ Remove the jammed paper.

Problem	Possible Causes	Solution
Saving data to memory card is slow	<ul style="list-style-type: none"> ■ Using a memory card below Class 4 may result in slower recording times. 	<ul style="list-style-type: none"> ■ Use a memory card with Class 4 or higher standard to improve performance.
Cannot write to the memory card	<ul style="list-style-type: none"> ■ The memory card has been locked. 	<ul style="list-style-type: none"> ■ Release the write lock of the memory card or replace with another card.
Too many movies to process	<ul style="list-style-type: none"> ■ The number of pictures or folders in the memory card exceed the specifications, so the playback can not be displayed. 	<ul style="list-style-type: none"> ■ Delete unwanted files.
The flash  flashes on the LCD screen.	<ul style="list-style-type: none"> ■ Current shooting environment requires flash. 	<ul style="list-style-type: none"> ■ Turn on flash.

Memory Card Compatibility

• Cards compatible with this camera (√ : Compatible X: Not Compatible)

	micro SD	micro SDHC	micro SDXC	Conversion adapter to SD card	SD	SDHC	SDXC
Format	FAT12, 16	FAT32	exFAT	-	FAT12, 16	FAT32	exFAT
Capacity	Up to 2GB	4-32GB	64GB-2TB	-	Up to 2GB	4-32GB	64GB-2TB
Compatibility	X	X	X	√	√	√	X

It indicates that the writing speed class will be displayed on the memory card.

Use a memory card with the appropriate writing speed for the video recording mode to be recorded.
(O: Recommended X: Not recommended)

	Speed Class	UHS Speed Class	Video Speed Class	Video Recording			
				4K	FHD	HD	VGA
90MB/sec			V90	O	O	O	O
60MB/sec		UHS-III	V60	O	O	O	O
30MB/sec		UHS-I	V30	O	O	O	O
10MB/sec	Class 10		V10	O	O	O	O
6MB/sec	Class 6		V6	X	O	O	O
4MB/sec	Class 4			X	X	X	O
2MB/sec	Class 2			X	X	X	O

© 2021 JK Imaging Ltd. All Rights Reserved.

The Kodak trademark, logo and trade dress are used under license from Eastman Kodak Company.

All other logos, products or company names that are referred to in this document are trade names, trademarks or registered trademarks of their holders. The holders are not affiliated with JK Imaging Ltd., our products or our website.

JK Imaging Ltd., 17239 So. Main Street, Gardena, CA 90248 USA

kodakpixpro.com

Made in Myanmar (Burma)

